



T218/T223

Design in Europe



PHONE:
(02) 9560 2811

WEBSITE:
www.labec.com.au

EMAIL:
sales@labec.com.au

ADDRESS:
26-30 Farr Street
MARRICKVILLE NSW 2204

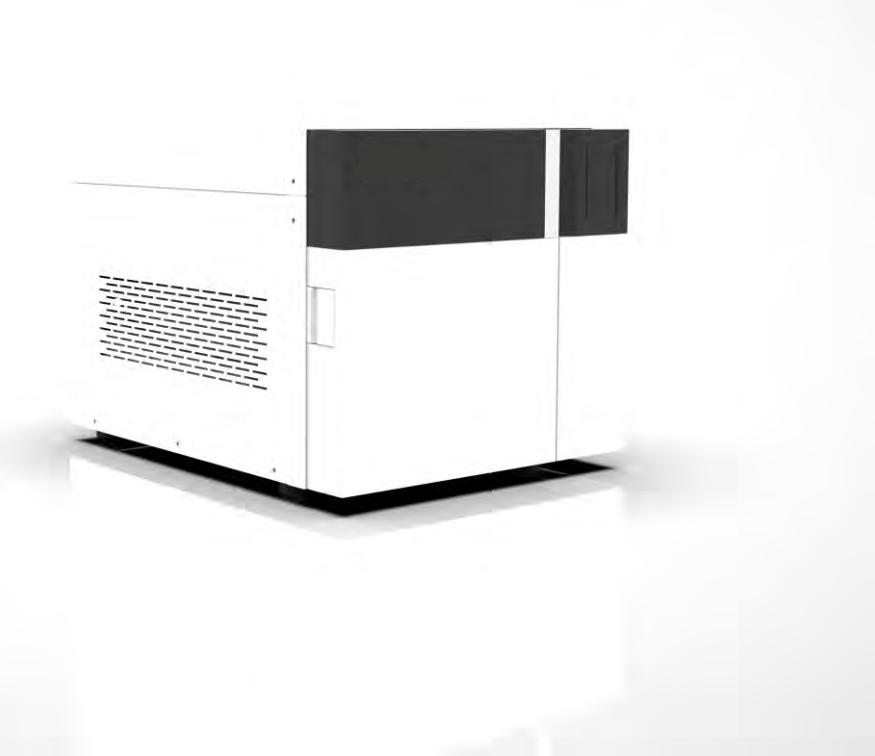

Simple Full Touch

Information about the functions, the progress of the operation, and the state of the sterilization are conveniently displayed on the screen which improves the customer experience.

The sterilization cycle can be selected quickly and directly from the program-related ICONS on the touch screen .



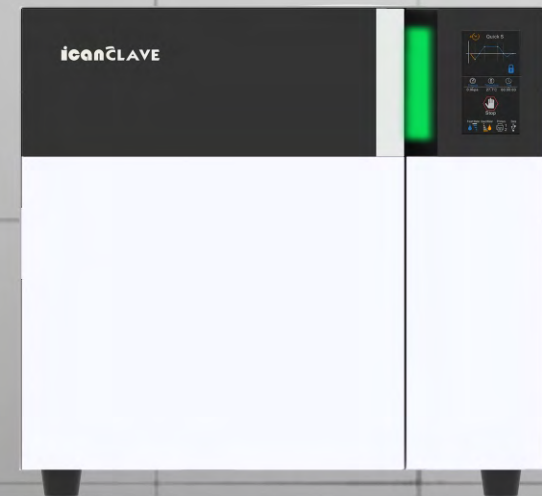

With the development of technology and great advances in the medical industry, coupled with the new and high demands of the recent standards and sterilization personnel, the sterilizer of the future faces major challenges, not only to meet the needs of a safe sterilization but also offer a modern appearance, high performance, faster sterilization and a better user experience. Iconclave T218 and T223 arrives to satisfy these requirements.

Innovative technologies
Design in Europe

Quick S cycle , 15 minutes

When a medical institution does not have many sterilizers but requires a lot of surgeries or the instruments need to be sterilized urgently, It must need a sterilizer has a quick cycle.

The fast S cycle sterilizes solid or hollow instruments quickly and effectively, helping to improve the workflow increasing the efficiency of the process, being also an effective solution when instruments need to be sterilized urgently.

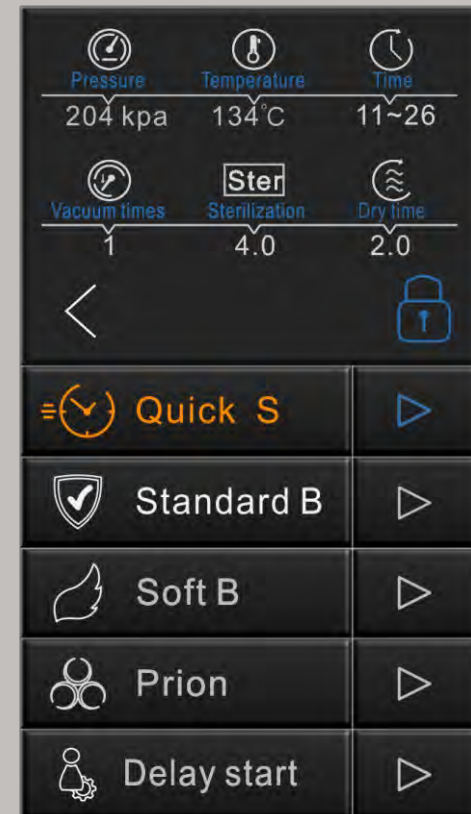



Sterilization cycle

PROGRAM	PROGRAM	STER. TIME	SUITABLE FOR		T218	T223
Quick S	134°C	4min	unwrapped solid instruments, unwrapped simple hollow instruments	Cycle Time* Drying Time* Load (Max)	11~15min 2min 1kg	15~20min 2min 1.2kg
Standard B	134°C	4min	Mixed load, Single wrapped solid instruments, Single hollow instruments	Cycle Time* Drying Time* Load (Max)	30~49min 15min 4.5kg	38~57min 15min 5kg
Soft B	121°C	20min	Mixed load, Single wrapped solid instruments, Single hollow instruments	Cycle Time* Drying Time* Load (Max)	38~54min 15min 4.5kg	46~62min 15min 5kg
Prion B	134°C	18min	Multiple wrapped instruments, Textiles, danger of infection instruments	Cycle Time* Drying Time* Load (Max) Load Textile(Max)	37~52min 15min 4.5kg 1kg	45~60min 15min 5kg 1.2kg

* The cycle time is based on the load and with/without pre-heating.

* Drying time can be adjusted.



BLUE	GREEN	RED
		
Switching on		
	Cycle process	
		Error

Light Signature

Three colors allow the operator easily to see the operating status of the sterilizer.



Water quality monitoring

The in-tank sensor checks the water quality at all times to prolong the life of the sterilizer and maintain its performance. It can print the water quality value in the cycle report.



Simplified water filling

ICANCLAVE T218 & T223 are equipped with manual water filling and draining by quick couplings, also can be equipped with an [automatic feed system](#) that withdraws demineralized water from an external tank. To make water feed even more simpler and more efficient, sterilizers can be connected directly to a demineraliser (optional).

Delay start cycle

The delayed start function allows the user to schedule a sterilization or test cycle a specific time and date.

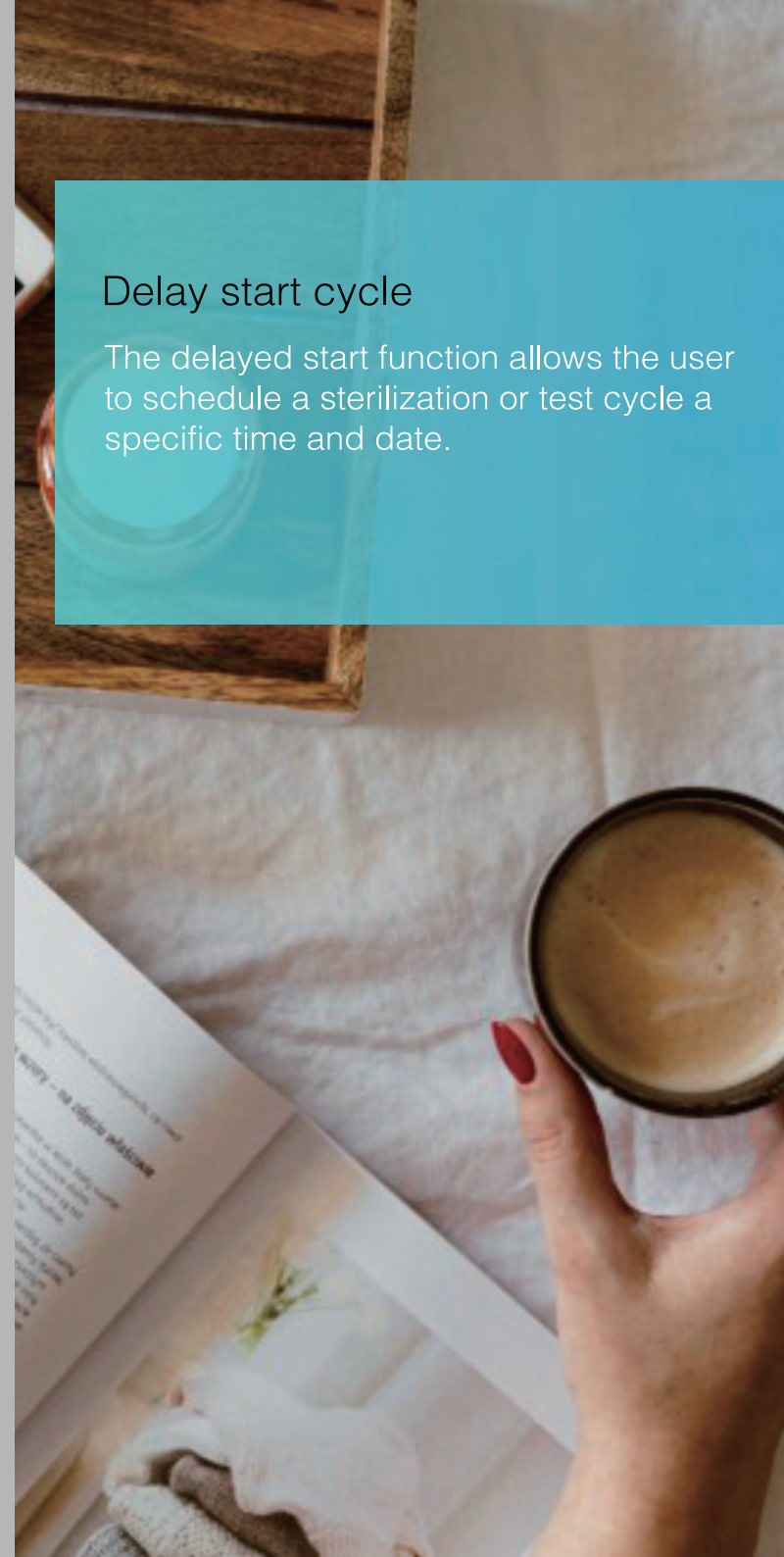

Report printing

The standard internal printer delivers a sterilization report after each cycle ends in the same way an optional barcode printer prints barcode labels that contain the information related to the sterilization cycle, making the traceability of the load easier and faster.

Data export

When the USB flash driver is plugged in, the cycle report will be stored after cycle finishes. The sterilizer also has an internal memory that can store up to 9999 cycles.

Descal cycle

Smart descale cycle included, which can full automatic clean the pipeline together with descale powder or liquid.

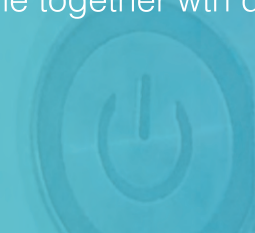

Trays and Chamber

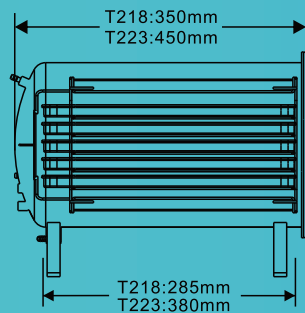
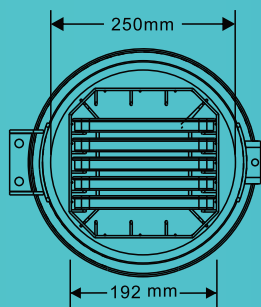

Accessories

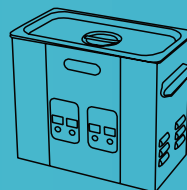

Ultrasonic Cleaner
Order code:
ICANCLEAN

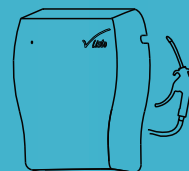

Water Deionizer
Order code:
Listo

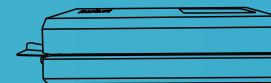

Sealing Machine
Order code:
SEAL 2019



Barcode Label Printer
Order code:
Icanlabel

Overall dimension

