

Haier



Ultra Low Temperature(ULT)Freezer Operation Manual

Certificate of Quality

checker:

Manufacturer: Qingdao Haier Biomedical Co., Ltd.
Address: Haier Industrial Park, Economic Technology Development
Zone, Qingdao P.R. China
Web: www.haiermedical.com
Revision Date: 02/2020
Version: 1st, 2020
Dedicated code: 0270501462
V13026



Model
DW-86L579BP
DW-86L729BP
DW-86L829BP
DW-86L959BP
DW-86L579BPT
DW-86L729BPT
DW-86L829BPT
DW-86L959BPT
DW-86L959W
DW-86L828W

- Read the Operation Manual carefully before using your appliance.
- Keep the Operation Manual in a safe place.
- Appearance, color and layout of the door may vary.
- Translation of the original instruction.

Content

Safety Labels and Safety Precautions	1
Usage Precautions	5
Product Feature.....	7
Installation	8
Freezer parts and control panels.....	12
Application method	15
Alarm	34
Cleaning maintenance.....	37
Recycling the Rechargeable Battery	39
Optional Accessories	40
FAQ	42
Refrigeration and Wiring Diagram	43
Specifications, Technical data and Packing list	46

Global Warming Potential

Model	Rated voltage(VAC)	Rated frequency (Hz)	CO ₂ equivalent(Tonnes)
DW-86L579BP	100-230~	50/60	0.0045
DW-86L729BP	100-230~	50/60	0.005
DW-86L579BPT	100-230~	50/60	0.0045
DW-86L729BPT	100-230~	50/60	0.005
DW-86L829BP	208-230~	50/60	0.0052
DW-86L959BP	208-230~	50/60	0.0052
DW-86L829BPT	208-230~	50/60	0.0052
DW-86L959BPT	208-230~	50/60	0.0052
DW-86L959W	208-230~	50/60	0.0052
DW-86L828W	208-230~	50/60	0.0052

This product contains fluorinated greenhouse gases covered by the Kyoto Protocol. Do not vent into the atmosphere.

GWP=global warming potential

Refrigerant type	GWP
R170	20
R290	20

DW-86L959W/828W Technical Data



Water flow regulator
Resetttable pressure switch
Brazed Plate exchanger (water-cooled condenser)

(Front View)



Water Filter

(Left View)



Water Outlet Water Inlet

(Back View)

1. Water pressure and Temperature

Water pressure: 20-150 psig, 100 psig is recommended.

Water Temperature: 15-32, 25°C is recommended.

2. Connections

Inlet 0.5" compression

Outlet 0.5" compression

3. Water Flow Rate Required(per minute)

1.0 gal.(3.8L)

4. Water PH value

6-9

5. Installation requires a qualified technician

The customer should dispose of a centralized water cooling system when using this feature!

*Actual requirements may vary due to specific water pressure conditions.

Safety Labels and Safety Precautions

Dear Haier Customers,

Thank you for purchasing a Haier ULT freezer. Please read this manual carefully to avoid injuries to personnel and damage to the product. Please also follow descriptions marked with the following labels.

Safety labels



Warning Electricity Crushing of hands Hot surface Low temperature Flammable material

	The upper and lower limits of temperature shall be indicated adjacent to the upper and lower horizontal lines.		Symbol for "Manufacture"
	Symbol for "Consult instructions for use"		Symbol for "Date of manufacture"
	European Authorized Representative	Elscolab BV. Tolboomweg 10, 3784 XC Terschuur, the Netherlands	

Wear Cryogloves before opening the door.	No sitting	Grounding mark	Complied with the requirements of MDD 93/42/EEC annex V

Safety precautions

	Warning	Ignoring this warning may result in death or serious injury
	Caution	Ignoring this warning may result in death or serious injury, and/or damage to the freezer and property
	Actions or operations which are prohibited	
	Actions or operations which must be followed	

- ! When a CO₂/LN₂ backup system is activated, the installation place must be well ventilated. Increased CO₂ in the air may be harmful and even fatal. If the ventilation is poor, other methods should be considered in order to ensure safe working environments.
- ! If there is a leakage of petroleum gas or other flammable gas, close the gas supply valve and open doors and windows to ventilate the air. Do not plug or unplug your freezer unit in order to avoid potential explosion or fire.
- ! Only professional technicians or Haier service personnel can install the unit. Failure to do so may cause electricity or fire.
- ! The freezer must be securely installed on a firm floor. Tilted installation may result in the product tipping over thereby causing injury and damage.
- ! Please use a dedicated power supply matching the requirement specified on the label to avoid fire and shock.
- ! If the voltage being used is 10% higher than the rated voltage, a regulator with a capacity of 4000 W or higher must be installed.
- ! If the power cord needs to be extended, the cross-section of the extended cable must be no less than 2 mm² and no longer than 3 m for products of 208V~230V/50Hz or 208V~230V/60Hz and no less than 3 mm² and no longer than 3 m for products of 115V~/60Hz to avoid fire or electric shock.
- ! Your Haier ULT unit is equipped with a standard three-prong power plug(grounded) complying with the standard three-prong socket (grounded) rated 16 A (208V~230V/50Hz or 208V~230V/60Hz) or rated 20A (115V~/60Hz). Removal of the ground prong is strictly prohibited for safety reasons under any circumstances. The electrical power plug should be securely plugged into the socket. A loose plug in the socket may cause fire.
- ! The power socket intended for your Haier ULT usage must be grounded to avoid electric shock.
- ! If the socket does not meet this requirement, the condition must be corrected by a qualified technician before using the ULT unit.
- ! Replacement of any spare parts should be performed by qualified technicians.
- ⊘ Never install your ULT in an unprotected area. If the unit is rained on, there is a danger of electric shock.
- ⊘ Your Haier ULT must not be installed in a damp area or an area subjected to water spray. Otherwise this may reduce the degree of insulation and thereby cause electrical leakage or electrical shock.
- ⊘ Never directly pour water into the unit. The water may cause electric shock or short circuit.
- ⊘ Do not place any water container or heavy object on top of the unit. A falling object may injure an operator. If the water spills into the unit, it may damage the insulation thereby causing electric shock.
- ⊘ Never use gas lines, water mains, telephone lines or lightening rods as the grounding device for your Haier ULT unit. This type of improper grounding may cause electric shock or other danger.
- ⊘ Do not touch any electrical components, switches or power cord with wet hands. Such action may lead to electric shock.

Technical Data

Model	Net Volume (L)	Rated Voltage (VAC)	Rated Frequency (Hz)	Rated Power (W)	Weight (kg)	Dimensions (W×D×H) (mm)
DW-86L579BP	579	100-230~	50/60	1100	320	895×998×1980
DW-86L729BP	729	100-230~	50/60	1100	350	1046×998×1980
DW-86L579BPT	579	100-230~	50/60	1100	320	895×998×1980
DW-86L729BPT	729	100-230~	50/60	1100	350	1046×998×1980
DW-86L829BP	829	208-230~	50/60	1100	380	1145×998×1980
DW-86L959BP	959	208-230~	50/60	1300	450	1296×998×1980
DW-86L829BPT	829	208-230~	50/60	1100	380	1145×998×1980
DW-86L959BPT	959	208-230~	50/60	1300	450	1296×998×1980
DW-86L959W	959	208-230~	50/60	1300	450	1296×998×1980
DW-86L828W	828	208-230~	50/60	1100	380	1145×998×1980

Packing List

Name	User Manual	Instruction to install sapcers	Plastic bag	Ice Scraper	Key	Spacer
DW-86L579BP	1	1	1	1	4	2
DW-86L729BP	1	1	1	1	4	2
DW-86L579BPT	1	1	1	1	4	2
DW-86L729BPT	1	1	1	1	4	2
DW-86L829BP	1	1	1	1	4	2
DW-86L959BP	1	1	1	1	4	2
DW-86L829BPT	1	1	1	1	4	2
DW-86L959BPT	1	1	1	1	4	2
DW-86L959W	1	1	1	1	4	2
DW-86L828W	1	1	1	1	4	2

Specifications, Technical data and Packing list

Specification

Name	Ultra Low Temperature Freezer
Model	DW-86L579BP/729BP/829BP/959BP/579BPT/729BPT/829BPT/959BPT DW-86L959W/828W
Exterior/Interior wall material	Coated cold rolled steel
Outer doors	Coated cold rolled steel
Inner doors	Plastic framed PS board
Shelves	Stainless shelves(height adjustable)
Porthole for testing	2
Insulation	Vacuum insulated with polyurethane foam(non-CFC)
Compressors	High stage:hermatically sealed Loe stage:hermatically sealed
Evaporator	Copper tube
Condensor	Finned coil
Refrigerant	R170 R290
Temperature controller	Microprocessor controller
Temperature display	LCD display or Digital display
Temperature sensor	RTD(Pt100)
Alarm device	High/Low temperature alarm, probe failure alarm, Hot condenser alarm, Ambient temperature alarm, Low battery alarm, Door ajar alarm, Power failure alarm
Battery of remote alarm terminals	Maximum load:30V DC, 2A Rechargeable battery:12V DC, charges automatically DW-86L579BPT/729BPT/829BPT/959BPT/959W/828W:Lithium battery DW-86L579BP/729BP/829BP/959BP:Lead-acid battery
Electric shock protection type	I
Ambinet temperature	10 to 32
Freezer temperature	-40 to -86
Foaming cabinet	HFO-1233zde
USB	Standard
RS485	Standard
pollution degree	2
overvoltage category	II

- ⚠ When unplugging the power cord from the socket, please grip the plug itself and pull it out. Do not pull the power cord as this may strip the wires out of the plug thereby causing electric shock and fire.
- ⚠ Should there be any malfunction in the equipment, power off the unit and unplug the power cord from the power supply. Continuous operation in an abnormal condition may result in electric shock and fire.
- ⊘ Never disassemble , repair , or modify the unit yourself . Any such work carried out by an unauthorized person may result in fire , or electric shock or injury due to a malfunction .
- ⚠ Before any repair and maintenance of the freezer, please disconnect the power to avoid electric shock or injury to personnel.
- ⚠ When repairing and maintaining your freezer, take precautions not to inhale any chemicals or aerosols floating inside and outside the unit. They might be harmful to your health.
- ⚠ If poisonous, radioactive or other harmful materials need to be stored in the unit, the equipment should be located in a safe zone. Improper usage of the equipment with such materials may harm the environment or operator's health.
- ⚠ If the unit is not in use for a long period of time, make sure the power cord is unplugged. Deteriorated insulation of the power cord may lead to electric shock or fire.
- ⚠ If the unit is to be stored unused in an unsupervised area for an extended period , ensure that children do not have access and that doors are locked completely with a key.
- ⚠ The disposal of the unit should be accomplished by appropriate personnel . Remove doors to prevent accidents such as suffocation .
- ⊘ Do not use any non manufacturer-approved electrical components in the freezer.
- ⊘ Never store flammable, explosive or volatile materials in the unit and do not use any flammable spray near the unit, as this may cause an explosion or fire.
- ⊘ Never store corrosive chemicals with acid or alkaline properties in the unit as this can lead to damage to internal components of the unit.
- ⊘ Do not place any glass container or enclosed container into the freezer. These containers may crack at low temperatures causing injury to operators
- ⊘ Do not put the packing plastic bag within reach of children as suffocation may result .
- ⊘ Do not climb on top of the unit or place any object on it. Falling equipment may cause injury or property damage.
- ⊘ Do not use any hard objects such as nails and wires to explore any openings or gaps such as air ventilation ports. Accidental contact between a hard object and a moving part may result in electric shock or injury.
- ⊘ Do not use electrical appliances inside the chamber of the appliance unless they are of the type recommended by the manufacturer .
- ⚠ The appliance must be positioned so that the plug is accessible.
- ⚠ The power plug is used as the disconnecting device.
- ⚠ The appliance must be placed on a solid and flat surface, or excessive vibration and noise may be produced when the appliance in operation.

- ❗ The appliance can be used by the persons with reduced physical sensory or mental capabilities or lack of experience and knowledge only if they have been given supervision or instruction concerning use of the appliance in a safe way and understand the hazards involved.
- ❗ If the power cord is damaged, it must be replaced by a qualified technician to avoid an electrical hazard.
- ❗ CP/IP foaming materials are flammable. They should be handled professionally.
- ❗ To avoid the risk of electric shock, this equipment must only be connected to a supply main with protective earth.
- ❗ There should be at least 30 cm space between the surrounding walls and the freezer for ventilation.
- ❗ Equipment cannot run in the condition of rich O₂ and flammable gas or liquid.
- ❗ After restarting your unit from a power outage or shutdown, ensure that all settings are correct. Accidental changes in settings may damage the stored products.
- ❗ In the event of a power outage and recovery, be sure to wait for at least 5 minutes before turning the unit on again to avoid damage to the compressors and refrigeration system.
- ❗ The air filter for the condenser should be cleaned regularly. A dirty filter could cause a malfunction or the freezer temperature to rise.
- ❗ During any repair operations, gloves should be worn to prevent getting injured by sharp edges or corners.
- ⚡ Do not use bare hands to directly handle any stored products. The cold temperature of the products and the interior walls may cause frostbite.
- ❗ Hold firmly onto the handle to close the door to avoid pinching your hands.
- ❗ Do not tilt the unit more than 45 degrees when moving the unit.
- ❗ When moving the unit, please be careful not to stumble with the unit which could cause injury to personnel and damage to the unit.
- ⚡ Do not attempt to use the handle to lift or move the unit to avoid damaging the freezer or injuring personnel.
- ❗ Please open the lock first, then lift the handle.
- ❗ Maximum loading on the each shelf should be no more than 50 kg and total loading for whole unit should be no more than 200 kg. Heavier loads may cause damage to the shelving system.
- ❗ Keep ventilation openings, in the appliance enclosure or in the built-in structure, clear of obstructions.
- ⚡ Do not use mechanical devices or other means to accelerate the defrosting process, other than those recommended by the manufacturer.
- ⚡ Do not damage the refrigerant circuit.
- ❗ Unauthorized opening of the top cover of the control cabinet is prohibited in order to prevent damage to the inside components or injury to the operator.
- ❗ Turn the battery switch on before starting the unit, do not arbitrarily turn it off.
- ❗ When the ULT unit has been placed in a storage or not in use for a long time, its battery should be tested for low capacity because the battery may have already released all of its energy. Should this occur, please turn on the battery switch and run the unit for about a week to fully charge up the battery.

•DW-86L829BP/829BPT/959BP/959BPT/959W/828W

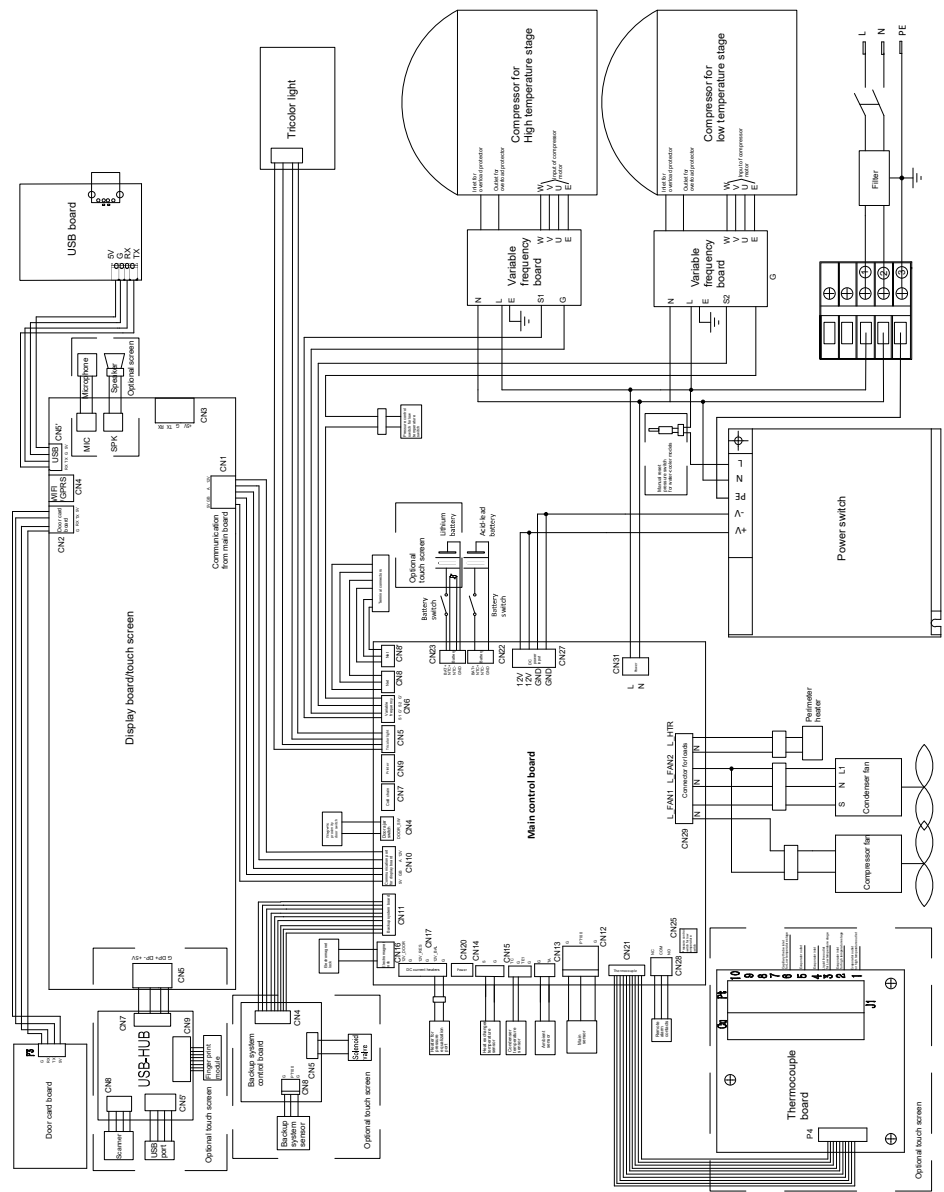

Refrigeration and Wiring Diagram

- Connect the equipment into an outlet on a circuit different from that to which the receiver is connected.

- Consult the dealer or an experienced radio/TV technician for help.

This device complies with Part 15 of the FCC Rules. Operation is subject to the following two conditions:

(1) This device may not cause harmful interference, and (2) this device must accept any interference received, including interference that may cause undesired operation.

FCC Caution: Any changes or modifications not expressly approved by the party responsible for compliance could void the user's authority to operate this equipment.

11.RF exposure warning

This equipment complies with FCC radiation exposure limits set forth for an uncontrolled environment. This equipment must be installed and operated in accordance with provided instructions and the antenna(s) used for this transmitter must be installed to provide a separation distance of at least 20 cm from all persons and must not be collocated or operating in conjunction with any other antenna or transmitter.

This equipment complies with ISED RSS-102 radiation exposure limits set forth for an uncontrolled environment. This equipment should be installed and operated with a minimum distance of 20cm between the radiator and any part of your body.

Pour se conformer aux exigences de conformité CNR 102 RF exposition, une distance de séparation d'au moins 20 cm doit être maintenue entre l'antenne de cet appareil et toutes les personnes.

12.Contains FCC ID: 2ASR8NFCV3, 2ASR8SC3832

13.This device contains licence-exempt transmitter(s)/receiver(s) that comply with Innovation, Science and Economic Development Canada's licence-exempt RSS(s). Operation is subject to the following two conditions:

(1) This device may not cause interference.

(2) This device must accept any interference, including interference that may cause undesired operation of the device.

L'émetteur/récepteur exempt de licence contenu dans le présent appareil est conforme aux CNR d'Innovation, Sciences et Développement économique Canada applicables aux appareils radio exempts de licence. L'exploitation est autorisée aux deux conditions suivantes :

(1) L'appareil ne doit pas produire de brouillage;

(2) L'appareil doit accepter tout brouillage radioélectrique subi, même si le brouillage est susceptible d'en compromettre le fonctionnement.



Meaning of crossed –out wheeled dustbin:

Do not dispose of electrical appliances as unsorted municipal waste, use separate collection facilities. Contact you local government for information regarding the collection systems available.If electrical appliances are disposed of in landfills or dumps, hazardous substances can leak into the groundwater and get into the food chain, damaging your health and well-being.

Refrigeration diagram

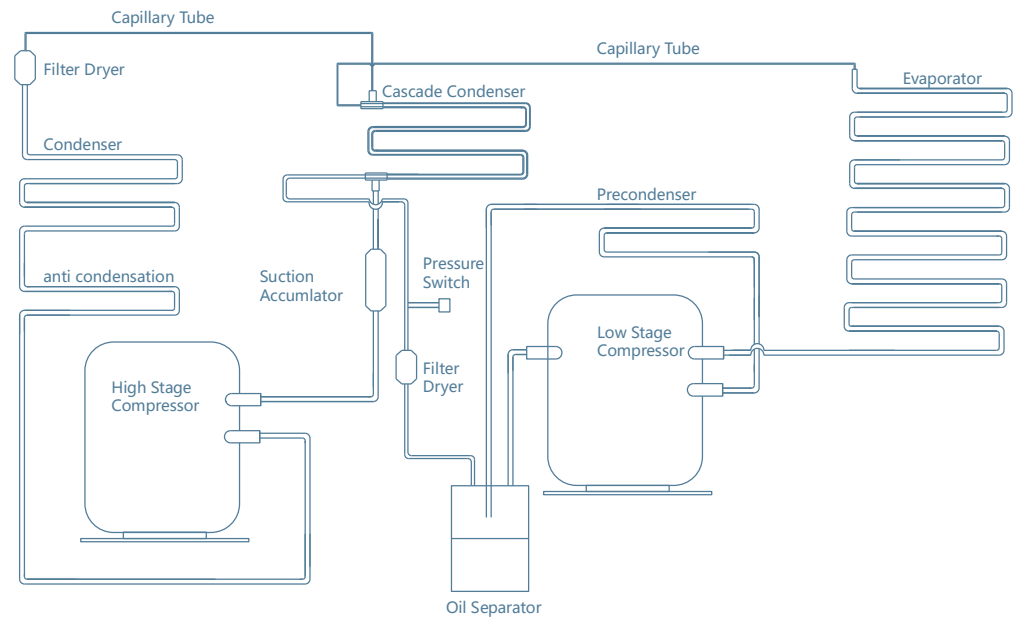

FAQ



Should there be any malfunctions in the system, please attempt to answer the following questions before notifying maintenance or calling a Haier Equipment & Instrument Service Center. Please do not dismantle the freezer yourself.

Fault	Troubleshooting
Freezer does not start up	Is the power supply normal? Has the main protector been turned on yet?
	Is the voltage supply too low?
	Is there any voltage input from the outside?
Poor refrigeration effect	Is the ambient temperature too high?
	Are the inner doors and outer doors closed properly? (Has any ice or frost damaged the seals between the door and the frame?)
	Is the condenser filter clogged?
	Is the temperature setting correct?
	Is the freezer being kept away from direct exposure to sunlight?
	Is the freezer near any heat source?
	Is the porthole plug installed in the porthole with proper insulation materials?
	Has the freezer been loaded with too many non-frozen samples within the last few hours?
The unit is noisy	Is the unit set on a firm and level floor?
	Is the exterior of the unit touching any objects?
	Is the freezer unit leveled with the leveling legs?

Product Feature

This product is suitable for the ultra low temperature storage of products in applications such as clinical, pharmaceutical, scientific research, and epidemic institutions. It also can be used in blood stations, hospitals, centers for disease prevention and control, science and research institutions, electronic and chemical laboratories, biomedical engineering institutions, and open sea fishery companies to store red blood cells, viruses, germs, skin, bones, bacteria, sperm, biological products, electronic components, and low temperature testing samples of special products, etc.

1. Temperature control

Temperature is controlled by computer and numerically displayed, and regulated in units of 1°C (LCD:0.1°C); temperature range: -40°C to -86°C .

2. Security system

- Various malfunction alarms (high/low temperature alarm, power failure alarm, probe failure alarm, hot condenser alarm, high ambient temperature alarm, door ajar alarm, low battery alarm).
- Two types of alarms (buzzer sounding alarm, flashing light alarm).
- Multiple levels of protection are standard including passcode and time-delayed start.
- All components are electrically grounded.

3. Refrigeration system

- Optimized multiple refrigeration technology with top brand frequency compressors offering better refrigeration capability.
- Excellent temperature preservation layer providing optimal temperature preservation effect.
- Exclusive sealing structure of multiple doors and hot tubing for condensation prevention can reduce the frost effectively.
- Specially designed low temperature computer control, to prevent the normal redundant systems from being erroneously controlled by the low temperature compressor.

4. User-friendly Design

- Display to indicate freezer temperature, ambient temperature and input voltage. Control panel to set the high/low temperature alarm and inner temperature. All malfunction alarms are also shown on the display.
- Designed with adjustable shelves, suitable for product storage.
- Safe lock design prevents accidental opening of doors.
- Installation in broad range of ambient temperature range of 10°C to 32°C environment.
- Unique all-in-one latch design and compact caster features allow ease of operation and maneuvering.
- Condensing fan motors are automatically controlled to turn on and off for energy saving.
- Network and remote alarm contacts are available as well for convenient connection and communication.

Due to our continuous improvement, Haier ULT freezers may appear to be different over time. User manuals are subject to change without notice.

Installation

Installation environment

- Ambient temperature:10℃ to 32℃ .The ideal temperature is 18℃ to 25℃ . If necessary, use an air-conditioning system to achieve the required ambient condition.
- Environment humidity: less than 57%RH.
- The intended location should be low in dust count.
- The intended location should be vibration and shock free.
- The highest elevation the unit can work safely: 2.000 m above sea level.
- Input voltage: within Rated Voltage $\pm 10\%$.

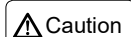

- An ULT freezer is usually sensitive to its operating environment. If a unit is not installed in the conditions mentioned above, it cannot operate reliably. Please improve the environmental conditions before using the equipment.
- It is prohibited to use the unit in an outdoor place. After the unit is rained on, there is a danger of electric shock.

Installation site

For the equipment to achieve optimal operating conditions, an intended installation location should satisfy the following requirements.

- Do not install the unit in a confined place. The doorway should be large enough for the unit to freely enter or exit the room if necessary. This is to allow the unit to be repaired easily and timely to avoid damage to property
- The location for installation should be flat and firm.
- There should be good ventilation and no direct sunlight.
- The freezer unit cannot share the same power socket with other equipment. The power plug should be securely connected with the power socket.
- The power cord for the freezer should not be twisted or pinched.
- If the power cord needs to be extended. the cross-section of the extended cable must be no less than 2 mm² and no longer than 3 m.
- Before using the freezer, check the voltage supply. A voltage stabilizer to deliver rated voltage $\pm 10\%$ is recommended for areas where the voltage is known to be unstable. The voltage stabilizer should be rated at least 4000W.
- The freezer must be securely grounded
- If the power socket is connected with a ground terminal, make sure to inspect it for proper connection before using the equipment.
- If the socket is not grounded, it must be connected to a grounded terminal by a qualified technician.

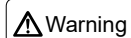

- Do not ground the freezer through gas lines, water mains, telephone lines and lightning rods as this may lead to electric shock.
- After installation, the power plug must be easy to reach. In case of emergency, it is easy to unplug. Nothing should block the ventilation port of the freezer.

- If the freezer operates in authorized mode, first ensure that the magnetic card or fingerprint is registered on it. When you can create a new account, the registration will be completed by swiping the card or punching the fingerprint, meanwhile a magnetic card shall be assigned to the new account. Only when the magnetic card corresponds to the login account, can the electromagnetic lock be unlocked.

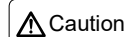

- If the user does not use the electromagnetic lock temporarily, it can be fixed with a clip, so as to ensure that the door can be opened / closed without swiping the card or using the fingerprint.
- When there is a loss of power or the backup battery power is out of power, please contact technical support personnel should there be a need to open the freezer door.
- If the card is not swiped or fingerprint information is not entered, the door should not be opened forcibly as it can damage the electromagnetic lock.

5.Frozen storage rack and frozen storage box

When the freezer stores small size of materials, the frozen storage rack and the frozen storage box can be used, so as to utilize the space more effectively.

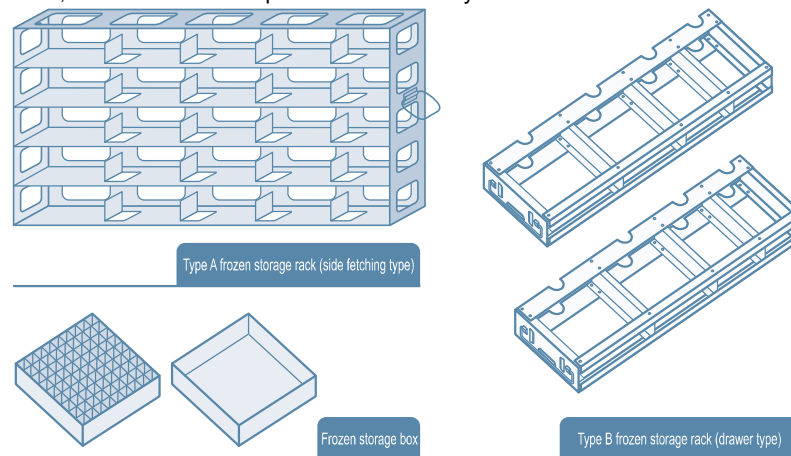

Model	Storage Rack(Type A/B are available)		Storage Box
	variety	Amount	Amount
DW-86L579BP	5×5	16	400
DW-86L729BP	5×5	20	500
DW-86L579BPT	5×5	16	400
DW-86L729BPT	5×5	20	500
DW-86L829BP	5×5	24	600
DW-86L959BP	5×5	28	700
DW-86L829BPT	5×5	24	600
DW-86L959BPT	5×5	28	700
DW-86L959W	5×5	28	700
DW-86L828W	5×5	24	600

Optional Accessories

1. Temperature recorder

When using the temperature recorder, please refer to the “User manual for Temperature Recorder” provided with the recorder.

Caution The temperature recorder should only be installed by professionals or Haier serviceman.

Warning Before installing the temperature recorder, please cut off the power supply to avoid electric shock or fire.

2. LCO₂ backup cooling system

For installation and operation of the backup cooling system, please refer to the user's manual provided with the system.

Caution For LCO₂ back up system, please make sure the LCO₂ supply bottle has an internal liquid dip tube to make sure the liquid is fed to the backup system. For LN₂ backup system, please use a LN₂ dewar of 35 to 50 psig.

Warning

- Whenever a CO₂ or LN₂ backup system is installed, the location of the freezer must be well ventilated. Increased concentration of CO₂ in the air is harmful and even fatal. If the ventilation is poor, alternative methods should be considered to reduce the nitrogen or CO₂ concentration to the normal level.

- If a LCO₂ or a LN₂ cylinder fell to the ground, its valves may get damaged, resulting in a risky condition. Fastening the bottles with a chain are to secure the them to ensure the bottles are positioned vertically and securely.

- The temperature of liquid CO₂ /LN₂ is extremely low, which could cause frostbite. When replacing the cylinder, please always wear a pair of protective glasses and protective clothes.

- This kind of backup cooling system should be used with the LCD panel.

3. Wireless cold chain module

The wireless cold chain module adopts wireless communication as a medium to realize the exchange between the specimen bank inside ultra-low temperature freezer and the specimen bank system, as well as the functions of data synchronization, management synchronization, operation synchronization and information synchronization.



4. Electromagnetic lock

- The electromagnetic lock can effectively enhance the safety of specimen access inside the freezer, which is convenient for use. When using it, make sure to swipe the card or use the fingerprint to unlock the lock before opening the door. If not swipe the card or use the fingerprint, or pull the handle forcibly, it may destroy the electromagnetic lock.

- Usage method: Before using the electromagnetic lock for the first time after unpacking, firstly open the door, and then remove the small clip for fixing the spring of electromagnetic lock.

- When the electromagnetic lock is unlocked, it may continuously maintain the open state for about 10 seconds. If more than 10 seconds later, you need to open the door once again, please swipe the card or punch the fingerprint. The unlocked/ locked state of electromagnetic lock is displayed on the touch screen.

- If the freezer operates in normal mode, any attached magnetic card can be used to open the door by swiping it in the card reading area of the display panel cover, but the fingerprint does not have the function.

Preparation before Use

1. Remove the packaging materials and strings

Remove all packing materials and straps for transportation.

2. Check the supplied accessories

Check the items in the packing box according to the packing list. If they do not match each other, please contact Haier immediately.

3. Installation environment

There should be at least 30 cm space between the surrounding walls and the freezer for ventilation.

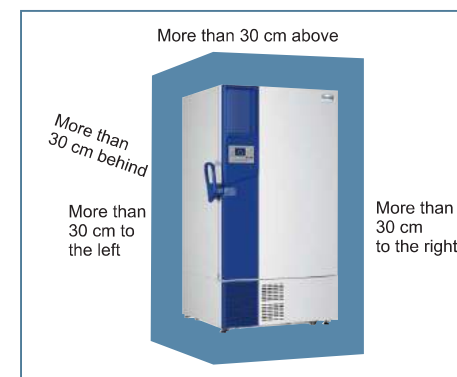

4. Adjust support legs

Rotate the leveling legs clockwise to extend them out to support the unit to the floor to ensure that the unit does not move while in usage.

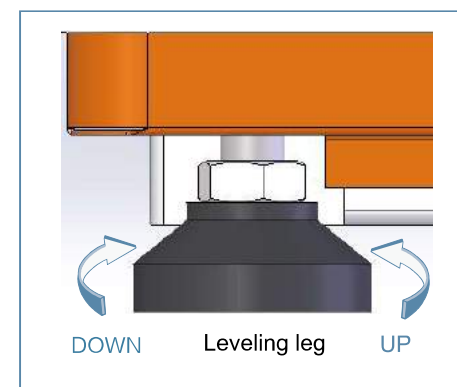

5. Placement

After adjusting and cleaning the unit, do not connect the power cord immediately. The freezer needs to be placed in its intended location for at least 24 hours before connecting the power to make sure it will operate normally.

Initially Powering Up

When the unit is started for the first time, please follow the procedures below.

① While keeping the unit empty, plug in the power cord to a dedicated power socket that meets all requirements.

② Please connect the freezer to the power supply, turn on the protector located on the right of the freezer (as in the illustration on the right), and then turn on the battery switch.

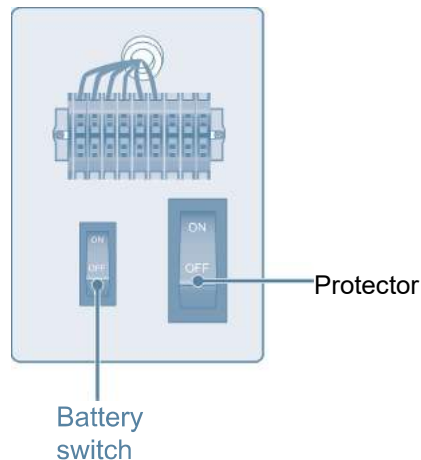

③ If the unit has a backup cooling system (optional), turn off the backup system.

④ Set the unit to a desired temperature: Do not load the unit with any samples. Power up the unit to let it run down to -60°C . Let it run at -60°C for 8 hours then lower it to -80°C . Observe the unit performance for 24 hours for normal cycling to ensure that it is working properly.

⑤ Once the unit is confirmed to be operating properly, it is ready to be loaded with samples. In principle, the freezer unit should be set at about 3°C above the desired temperature. For example, if the storage temperature is -60°C , set the unit at -57°C . Load the unit with samples in batches of less than 1/3 of the unit's capacity. Make sure that the unit is capable of cycling for more than 8 hours.

⑥ If the unit has a backup cooling system (optional), turn it on.

Recycling the Rechargeable Battery

The Haier freezer is equipped with a rechargeable battery. This battery is recyclable. When the battery reaches the end of its life, please contact a local recycling organization for inspection or properly discard the battery.

1. Location of the battery

The battery in the electric cabinet is for the power outage alarm. It is located inside the control box of the right side of the unit.

! To prevent electrical shock, only a qualified technician should replace the battery.

2. Removal of the battery

- Turn off the power of the unit and unplug the power cord from the socket.
- Use a screwdriver to remove the screws on the side panel and take down the side panel.
- Unplug the connecting terminals from the battery.
- Remove the bracket that fastens the battery. Remove the battery.
- Follow regulations to recycle the battery or discard it properly.

⊘ When changing the battery, you must make sure that the brown wire connects to the positive pole of the battery, and the blue wire connects to the negative pole of the battery. The polarity must not be reversed. Incorrect polarity can damage the main control board so that it cannot charge the battery.

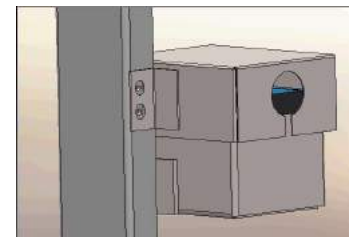

⚠ Caution After interruption of power supply, the battery can maintain the standby time of the touch screen for 22 hours (DW-86L579BPT/729BPT/829BPT/959BPT/959W/828W).

- Load the samples back into the unit after it reaches the set temperature.

- Turn on the backup refrigeration system if there is one.

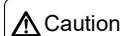
 **Caution** Do not use any sharp tools such as knives or screwdrivers to defrost.

4.Battery maintenance



- When the control panel shows an alarm signal for “Low Battery ”, please make sure the battery switch is turned on, and the battery will be charged. After about one week of charging, please recheck the battery capacity. If normal, the battery should be in full capacity. However, if the capacity is still low. please change the battery.

- The battery that supports the power outage alarm is a consumable item. The life expectancy for the lithium battery is 5 years(Lead-acid battery is 2-3 years.). If the battery is more than 5 years old(Lead-acid battery is 2-3 years.), the battery should be replaced because the alarm function may not work properly. To do so, please contact an Haier Equipment and Instrument Service Center.

5.Disposal of the freezer

 **Warning**

- If the unit is to be stored unused in an unsupervised area for an extended period, ensure that children do not have access and that doors are locked completely with a key.
- The disposal of the unit should be accomplished by appropriate personnel . Remove doors to prevent accidents such as suffocation .

-  • If the freezer temperature warms up, and the issue can't be resolved within a short time, please transfer the stored products to another freezer to avoid potential damage..
- Before placing samles in the freezer for storage, check the freezer temperarture to make sure the temperature meets the storage requirement for the samples. This is to prevent any potential damage to the samples due to incorrect storage temperature.
- Due to the fact that it would take time to remove the heat from the stored product, there can be a difference between the set temperature and the displayed temperature. This difference will get smaller as the set point is lowered.
-  •Ultra low temperature freezers are designed to store samples. Therefore, they are not suitable for heavy loading with a large amount of products at one time as the operation can cause premature compressors over heating. Samples should be loaded in small batches. The temperature setting should be lowered incrementally, allowing the unit and products are stablized at each setting until the final temperature is reached.
- Do not use any unauthorized mechanical tools or other means to accelerate the defrosting process.
- Do not tamper with the refrigeration circuit.
- Do not use any non manufacturer-approved electrical components in the freezer.

■ Operation after a Power Outage

Haier ULT freezers' control settings are stored in their memory system. Should there be a power outage and recovery, freezer units can resume its operation based on the previous settings.

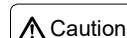
-  **Caution**
- In the event of a power outage and recovery, be sure to wait for at least 5 minutes before turning the unit on again to avoid damaging the compressors and refrigeration system.
 - If the unit is not in use for a long period of time, make sure the power cord is unplugged. Deteriorated insulation of the power cord may lead to electric shock or fire.
 - If the freezer is not in use in an area without any supervision, please make sure children will not approach the freezer and the doors should not be closed.

Freezer parts and control panels

Freezer parts

•DW-86L579BP/729BP/829BP/959BP



Cleaning maintenance

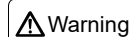

Warning

- To prevent electric shock or injury to operators, the AC power supply to the freezer must be disconnected completely before any repair and maintenance work is to be performed.

- During any repair maintenance work, do not inhale medical particles or aerosols near the equipment as they might be harmful to your health.

1.Cleaning the freezer

- Clean the unit once a month.This can help the exterior look new.
- Use a dry cloth to wipe away loose dust inside and outside of the freezer. If the unit is rather dirty, use a clean doth soaked with a neutral detergent to clean the unit. Then use a dry cloth to wipe away any residual detergent solution.
- Never pour water onto or into the unit. Doing so can damage the electric insulation and cause failure.
- Compressors and other mechanical parts are hermetically sealed. They do not need lubrication. Users should remove the frost on the chamber and clean the condenser filter as often as possible.

2.Cleaning the condenser filter

Clean the condensor filter when the control panel shows an signal for "Hot Condensor" and the alarm flashes. Even if the light is not on, the condensor filter should be checked regularly according to the suggestion from the distributor.

To clean the filter, follow the procedure below.

1. Pull off the front grill cover.
2. Pull out the filter screen.
3. Use water to wash the filter screen.
4. After the filter screen is dry, reinstall it back in its original position and close the cover.
5. If the "Hot Condenser" light is on before cleaning, check the light to make sure that it shuts off after cleaning. If it does not shut off, please contact after-sales service personnel.

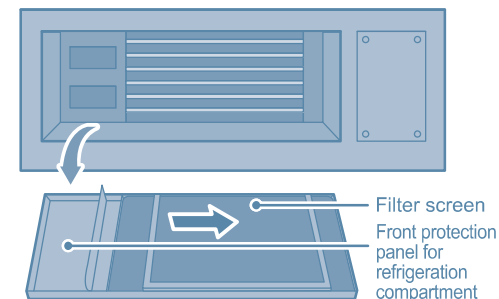

3.Defrost

Frost and ice can form in between the door gasket and frame to form an air gap, which can decrease the refrigeration effect of the unit. Please use the provided plastic scraper to defrost the interior doors.

To defrost the units, please refer to the instruction as follows.

- Turn off any backup refrigeration system if there is one.
- Remove the samples from the unit that needs to be defrosted. Move them to another unit or a container for temporary storage.
- Turn off the power supply.
- Open the outer door and inner doors to let the unit thaw for a period of time.
- Use a dry doth to soak up and remove any water on the floor of the unit.

Remote alarm terminal

- The remote alarm terminal is installed on the right side of the freezer's engine cabin, and the alarm signal will be output by this terminal. The load capacity of the terminal is DC 30V, 2A.

- Contact output:

The remote alarm terminal is divided into: Normally open, normally closed, common terminal.

Users may select normal open or normal close according to their own requirements.

- Standard R485 port can be used to transmit freezer temperature data to customer's software for monitoring

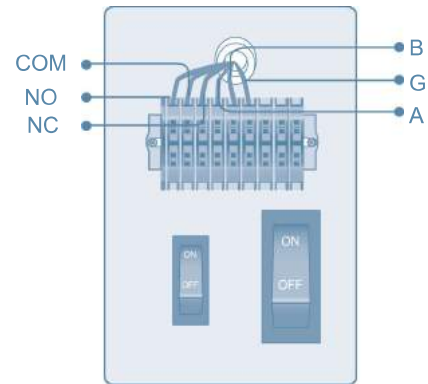

•DW-86L579BPT/729BPT/829BPT/959BPT/959W/828W

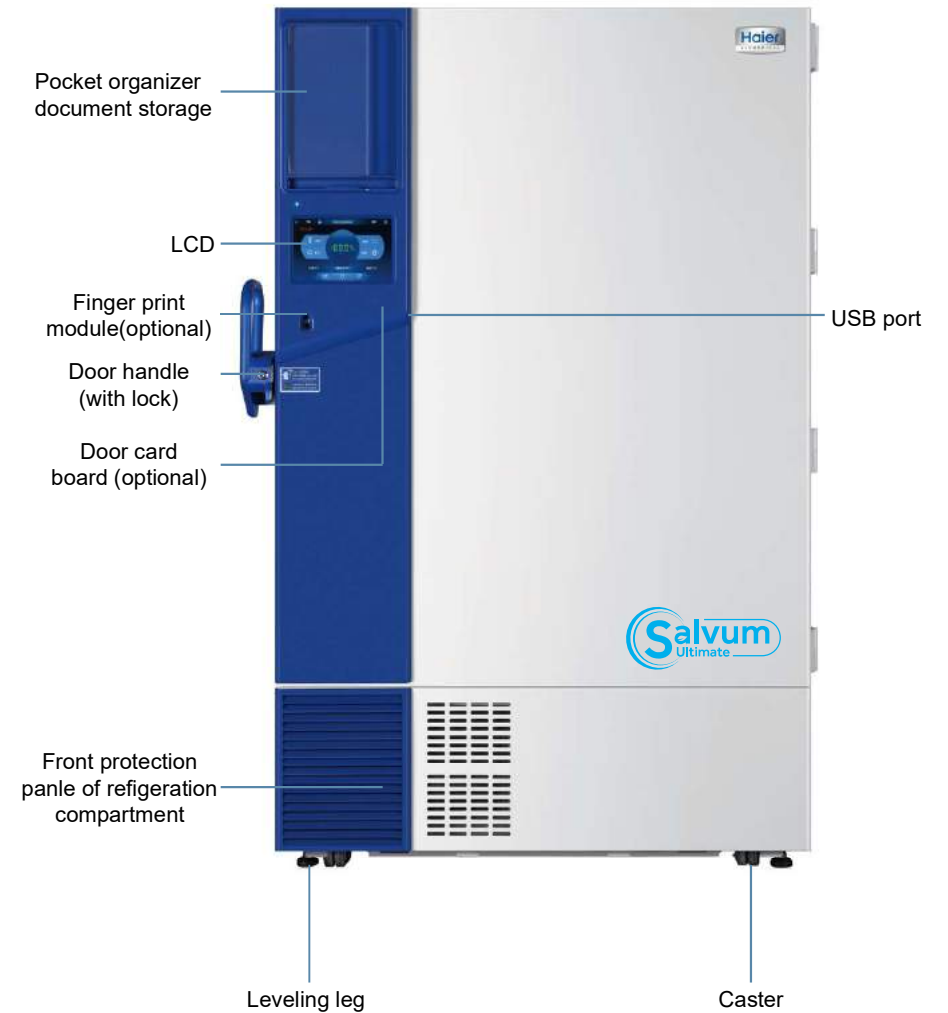

Control panel

•DW-86L579BP/729BP/829BP/959BP

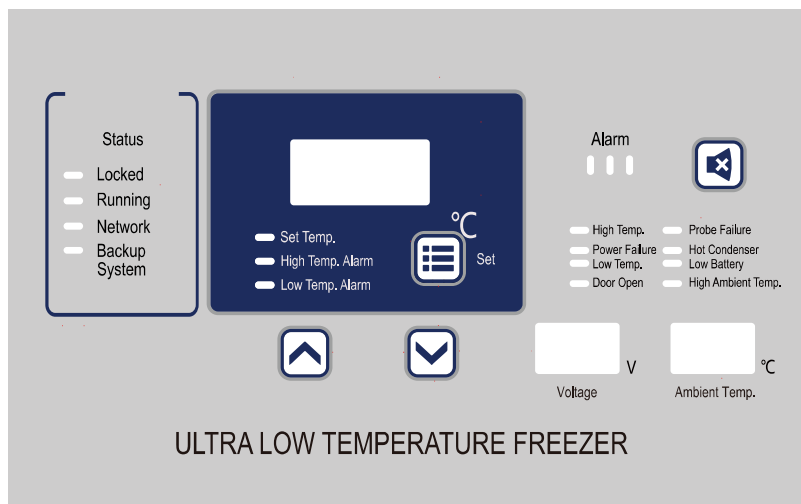

•DW-86L579BPT/729BPT/829BPT/959BPT/959W/828W



Caution • A flashing alarm cannot be cancelled unless the malfunction is eliminated. The buzzing alarm can be temporarily silenced for 30 minutes by pressing the "Silence" key. However, if the problem is not fixed, the buzzer alarm will resume after 30 minutes.

- When using the freezer, the battery switch must be turned on to charge the battery.
- When there is a power outage, the battery sustains the temperature display. If the battery voltage is insufficient, the temperature display will turn off.
- While the battery is still capable of providing power to the display, the temperature display can be turned off by unplugging the power cord and turning off the battery control switch.
- The freezer is also designed to auto-adjust the inner temperature set point in high ambient temperatures. When the ambient temperature is warmer than 35°C and the set point temperature is set to be lower than -82°C, the set point temperature will automatically default to -82°C. If the ambient temperature is equal to or cooler than 30°C, the set point will resume at the intended inner set point. This feature extends the life expectancy of the freezer.

DW-86L579BPT/729BPT/829BPT/959BPT/959W/828W

Alarm Type	Tricolor lamp panel	Buzzer	A prompt box pops up.
High-low temperature alarm	Red	Y	Y
Power-off alarm	Red	Y	Y
Door opening alarm	Red	Y	Y
Main temperature sensor fault alarm	Yellow	Y	N
Heat exchanger fault alarm	Yellow	Y	N
Condenser dirty alarm	Yellow	Y	N
High ambient temperature alarm	Yellow	Y	N
Battery fault alarm	Yellow	Y	N
Backup system fault alarm	Yellow	Y	N

Automatic recovery of alarm

- Under alarm, the beeper alarm could be ceased by pressing any key, and the flashing alarm and remote alarm will not be ceased (DW-86L579BPT/729BPT/829BPT/959BPT/959W/828W: Click "x" on the upper right-hand corner in the prompt box to stop the buzzer alarm. If there is no prompt box, click the alarm on the bottom of the homepage to view the alarm, and then stop the buzzer alarm.).
- If the alarm condition is still available, the beeper alarm will be recovered automatically 30 minutes after ceasing.

Alarm

DW-86L579BP/729BP/829BP/959BP

Supply power to the storage box and turn the protector to "ON" position to enter into the startup status. The display panel shall display the ambient temperature, set temperature and current voltage.

Working status of the display panel:

"Locked" indicator lamp is ON: It means that all settings are locked to avoid maloperation.

"Network" indicator lamp is ON: It means that the network system is in service.

"Running" indicator lamp is ON: It means that the low-temperature compressor is in service.

"Backup system" indicator lamp is ON: It means that the backup refrigeration system is in service.

Alarm:



Alarm	Status	Code	Instruction	Buzzer	Remarks
High temperature alarm	The current temperature \geq the high temperature alarm value for 1 minute on end.	E00	The alarm lamp flashes ON and OFF.	The buzzer gives an alarm.	For the first time to power on device, the judge is not made before compressor's first time halt, the judge will be made after compressor's first time halt.
Low temperature alarm	The current temperature \leq the low temperature alarm value for 1 minute on end.	E01	The alarm lamp flashes ON and OFF.	The buzzer gives an alarm.	
Ambient temperature alarm	Ambient temperature $\geq 35^{\circ}\text{C}$ (35 $^{\circ}\text{C}$ as default)	E02	The alarm lamp flashes ON and OFF.	-	-
Sensor failure	Failure of the main sensor	E10	The alarm lamp flashes ON and OFF.	The buzzer gives an alarm.	-
	Failure of the heat exchanger sensor	E11			-
	Failure of the sensor for ambient temperature	E12			-
	Failure of the condensing sensor	E13			-
Low battery	The battery switch is off	E20	The alarm lamp flashes ON and OFF.	The buzzer gives an alarm.	-
	Reverse battery insertion(for platonic acid battery)	E21			-
	battery power is not enough	E22			-
Power failure alarm	Power failure of the freezer	E30	The alarm lamp flashes on and off, the display panel does not work or works alternatively.	The buzzer gives an alarm.	-
Door open alarm	More than 5 minutes of door opening (5 minutes as default)	E40	The alarm lamp flashes ON and OFF.	The buzzer gives an alarm.	-
Hot condenser	The condenser filter screen is clogged	E50	The alarm lamp flashes ON and OFF.	The buzzer gives an alarm.	-

Application method

DW-86L579BP/729BP/829BP/959BP

1.Unlocking the freezer



Be sure to unlock firstly for adjustment of set value.

- Press the " " or " " and adjust to the number "06".
- Press the "Set" key for 5 seconds when the "locked" lamp is OFF to get various settings under unlocking status.
- Press the "Set" key to set the temperature inside the box, high-temperature alarm and low-temperature alarm in a circular fashion while the corresponding indicator lamps are ON.



2.Setting the inner temperature

•In unlocked mode, press "Set" key to select "Set Temp.", the temperature display flashes and displays the setting value.

•Then, press " " or " " key, adjust the temperature setting value .

Temperature setting range:-10 to -86 $^{\circ}\text{C}$. Recommended temperature setting range:-40 to -86 $^{\circ}\text{C}$.

•After adjustment, do not touch the unit for 10 seconds. The unit automatically enters the locked mode and the temperature display stops flashing which means the value set have been input into computer. Otherwise, the setting is invalid.

For example: Set the inner temperature to -80 $^{\circ}\text{C}$.





•After setting the inner temperature, the high temperature alarm and low temperature alarm will automatically adjust to proper values accordingly.

If user has special requirements, follow the following steps to adjust the values manually.

3.Setting the high temperature alarm

•In unlocked mode, press "Set" key to select "High Temp. Alarm", the temperature display flashes and displays the setting value.

•Then, press " " or " " key, adjust the high temperature alarm setting value.

Temperature setting range: at least +5 $^{\circ}\text{C}$ above the inner temperature.

•After adjusting, do not touch the unit for 10 seconds. The unit automatically enters the locked mode and the temperature display stops flashing which means the value set have been input into the computer. Otherwise the setting is invalid.

For example: If inner temperature is set to -80 $^{\circ}\text{C}$, setting the high temperature alarm to -75 $^{\circ}\text{C}$ is recommended.



4. Setting the low temperature alarm

•In unlocked mode, press "Set" key to select "Low Temp. Alarm", the temperature display flashes and displays the setting value.

•Then, press "▲" or "▼" key, adjust the low temperature alarm setting value.

Temperature setting range: lowest at -91°C, and 5°C or higher than the inner temperature setting.

•After adjusting, do not touch the unit for 10 seconds. The unit automatically enters the locked mode and the temperature display stops flashing which means the value set have been input into the computer. Otherwise, the setting is invalid.

For example: Set the low temperature alarm to -91°C.



5. User parameters

•Parameters: dA, T1, T2, P6, IC, PS1, CL1.

•Entry mode: After the display board unlocks and the unlocking indicator lamp is OFF, Press and hold the "▲" to 5s and enter into user parameters;

•Press the "▲" or "▼" key to select dA, T1, T2, P6, IC, PS1 and CL1 after accessing to the user parameters;

select one of these parameters and then press the "Set" key to modify this parameter.

6. Regulation mode and scope of parameter value

•dA: 5 min is the default value for the delayed door open alarm. It is adjustable from 1min to 30min;

Press the "▲" or "▼" key to modify the set value of delayed door open alarm;

•T1: 6 min is the default value for the USB data reading cycle. It is adjustable from 1min to 99min;

Press the "▲" or "▼" key to modify the set value of USB data reading cycle;

•T2: USB timing, MM(P2:01~12)/DD(P3:01~31)/YYYY(PI:10~99)/Hour(P4:00~23)/Minute(P5:00~59);

Press the "▲" or "▼" key to modify the timing of USB;

•P6: 12 is the default value for USB derivative mode; it is adjustable from 0 to 12;

The data can be exported in different time frames with parameters of 0~12, among which, 12, as default, means exporting the data generated from 1 year by one time; 0 means exporting all data by one time; 1-12 means exporting the data generated from previous months, such as 2 months, 3 months...12 months.

Press the "▲" key or "▼" key to modify the USB derivative;

•IC: 008 is the default register password of IC card; it is adjustable from 000 to 999;

Press the "▲" key or "▼" key to modify the register password of IC card.

•PS1: 06 is the default value for the unlocking password; it is adjustable from 01 to 99;

Press the "▲" key or "▼" key to modify the unlocking password;

Setting method: Press the "▲" key or "▼" key to get +1/-1 for the password; Press and hold the "▲" key or "▼" key to get +1/-1 every 1s; it will increase or decrease 10 every 1s when continuous addition or decrease of 10 takes place.

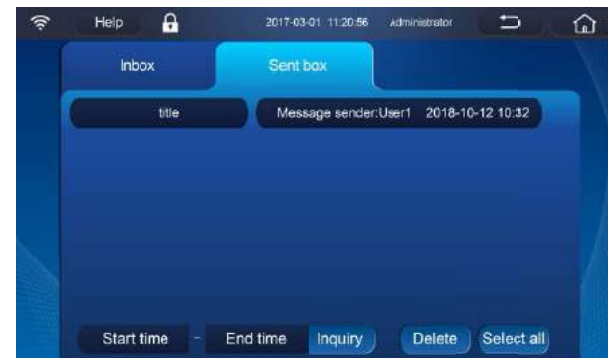

•Notebook

It can be used to create new message, and view the records. For previous records, you can directly click them for modification and saving in the pop-up interface; when clicking [Delete], you can delete one or all messages.

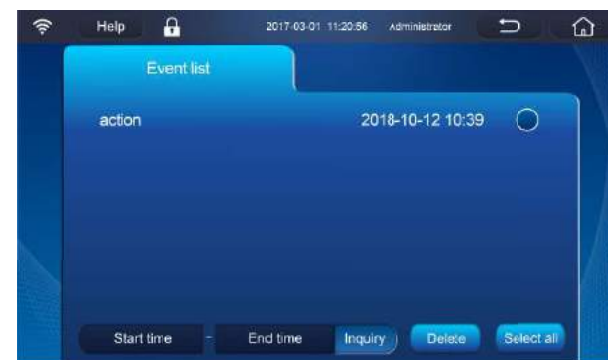



•Message box

[Inbox]

You can click "Inbox" to view the messages that have been received. When a message has been read, its fonts become gray.

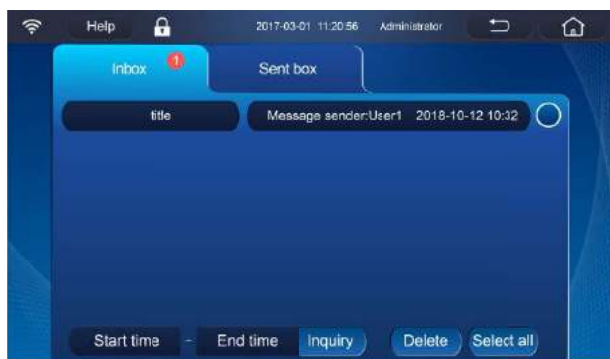

[Sent box]

You can click "Sent box" to view the message that has been sent .

•CL1: 0 is the default value for cancelled IC card; it is adjustable from 0 to 1;
 Select CL1 to access the parameter list. Press the "Set" key and 000 flickers to demand you to enter the password. Then press the "Set" key again to execute the order when CL flickers 3 times and then the buzzer rings once. Here cancellation is done. If the password entered is wrong three time in succession, exit and lock it and re-display the temperature inside the box.

7.IC Card Registration Mode

1) Unlock the display screen. Now the lock indicator lamp is extinguished. Then press the " " button for 5s to show "000", the input value of IC card registration password in the chamber temperature display area. Press the " " or " " button to change the password input value to "008". Press the "Set" button to call up the IC card registration screen to display the current number of IC cards. If the current number of IC cards is 0, the value of "--00" is shown on the display and now it is possible to register IC cards;

2) When swiping each new IC card, the buzzer will sound once and the number of IC cards will be increased by 1, e.g., "--01";

In case of swiping a registered IC card, the buzzer will sound once, however the number of IC cards will not be increased by 1;

3) Up to 99 IC cards can be registered;

4) When showing the current number of IC cards, press the " " button to return to the upper level, i.e., the temperature setting parameter mode, or if there is no button pressing or card swiping for 20s, the function will be blocked and the screen will return to display the chamber temperature;

5) The electromagnetic lock can not be released in the state of registration;

8.USB-based Data Export

Plug in a USB flash disk to enable automatic export of the machine's temperature, alarm and event records. Once the data is exported, the decimal point at the bottom right corner of the rightmost digital tube which is used to display the temperature starts to flash. When the data exporting process is finished, the decimal point remains normally ON without flashing. Remove the USB flash disk. Now the decimal point goes out.



•The system memory can save data for 10 years.

•When export data to USB disk, please use an USB disk with a file format of FAT32.

•If the FAT32 USB disk cannot export data, please backup the file of the USB disk first and then format the USB disk or try another brand FAT32 USB disk.









1.Homepage



In the home page, it can display the real-time internal temperature, ambient temperature, set point, input voltage, backup system state (optional), network state, electromagnetic lock state (optional), user login status, freezer health status, temperature graph, and message/ note book, etc..

•Icon of real-time internal temperature:

The icon reflects the health status of the freezer by changing colors:When the system is running normally, the color is "Green";When the system occurs a general alarm that does not affect the internal temperature, the color is "Yellow", for example, ambient temperature alarm;When the system has a serious alarm affecting the internal temperature, the color is "Red", for example, power failure alarm.

-  Click to enter the sample management login interface
-  Click to enter the graph viewing interface, where the temperature records can be downloaded
-  Click to enter the information query interface
-  Click to enter the freezer setting interface
-  Indicate that the network is enabled
-  Indicate that the electromagnetic lock has been installed, which is in the locked state
-  Click to enter the interface of configuring the sample bank server address and port.
-  Click this button to enter the Alarm Record interface and the alarm record can be downloaded. When occurring a serious alarm that affects the temperature inside the freezer, the icon turns red, and when occurring a general alarm not affecting the internal temperature, the icon turns yellow. The buzz can be cancelled after clicking.

The user can query the name, model and machine code of this freezer, as well as version information of touch screen program.

You can view the electronic manual by clicking [Electronic manual].

Configuration: Click "Download" to download the set parameters of this freezer to a USB disk in the established format via USB, and then plug the USB disk that has saved the downloaded file to the USB interface of other freezers; after that, click "Upload" to upload this configuration file to other freezers, so as to realize that multiple machines can share the set parameters.

Database: Click "Download" to download the temperature data, alarm records, event records of this freezer to a USB disk in the established format via USB, and then plug the USB disk that has saved the downloaded file to the USB interface of other freezers; after that, click "Upload" to upload this database to other freezers, so as to realize that multiple machines can share the data.

Upload/download configuration files or databases:They can be uploaded or downloaded optionally via USB,so as to achieve the purpose that multiple machines can share the set parameters or saved data.

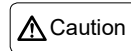

- When export data to USB disk, please use an USB disk with a file format of FAT32.
- If the FAT32 USB disk cannot export data, please backup the file of the USB disk first and then format the USB disk or try another brand FAT32 USB disk.

5.Message

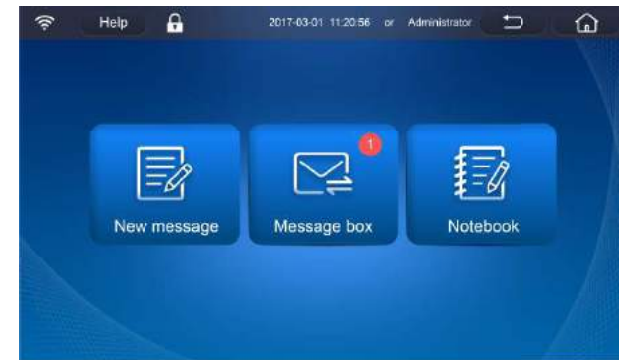

•New message

Create a message by clicking on "New message". In the interface of "New message", click "+" to select the users whom the message will be sent to, enter a title in the title bar, and enter the message content in the text box, then click "Send".



For the accumulated injection time, it displays the accumulated injection time since the last start-up.

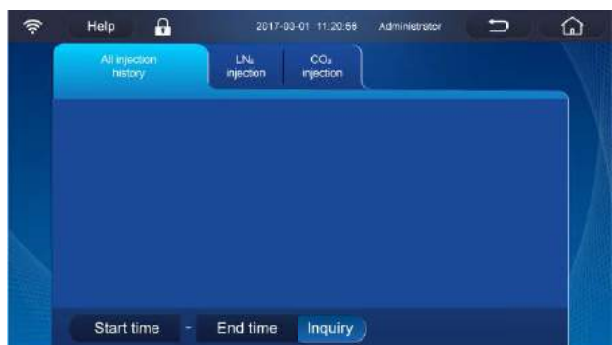

Enter/input "Start time-End time", and then click "Inquiry" to query the spraying record in this interval. One or several injection history can be deleted to the spraying history.

• Device information

It can be used to query and save the related information, electronic manual of the freezer, as well as upload/ download its configuration file and database information.

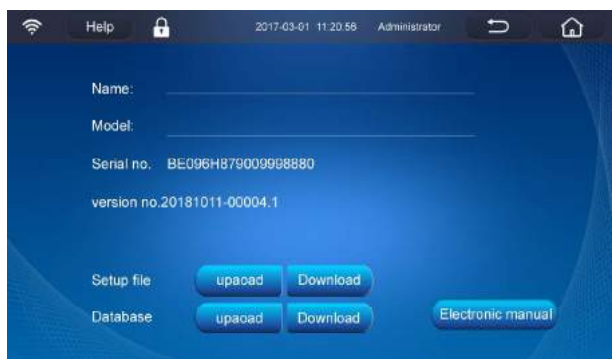

Click to enter the interface of message and note book .

Backup system ● With this icon/identification: Indicate that the system is turned on;
 Green light :Indicate that it is being sprayed;
 Grey light: Indicate that there is no spraying.

System A ● When the A/ B system is not running, the icon will display "Gray"; when in normal operation, the icon will display "Green"; and when a certain system fails, the icon corresponding to this system will display "Red". (only for dual-system products)

System B ● Help: you can click this button to enter the help interface.

Log in/ Log out: Click the Login button to pop up the user login interface., and click the Logout to log out the current account number.

2.Setting

The page has six buttons: Temperature, Initial, Operation, Backup, Network and User.



•Temperature

It can set the internal temperature and high-/ low- temperature alarm value. Select the internal temperature value or high-/ low- temperature alarm value to be set, and then use the button of "+" / "-" for adjustment(You can also pop up a value selection box by clicking the value, and select the value by scrolling the selection box up and down). Click Save to finish settings.



[Set point]

It is used to set the required temperature inside the freezer, with the adjustable range of -10°C ~-86°C .

[Low temperature alarm]

It is used to set the alarm value of too low temperature inside the freezer, with the adjustable range of -15°C ~-99°C , which needs to be lower than or equal to the internal temperature value for 5°C . When the set value of internal temperature is changed, if the low temperature alarm value is not lower than or equal to the temperature value inside the freezer for more than 5°C , the low temperature alarm value will be automatically adjusted to "the set value of internal temperature - 5°C . If the low temperature alarm value is lower than or equal to the temperature value inside the freezer for more than 5°C , the low temperature alarm value will not change.

[High temperature alarm]

It is used to set the alarm value of too high temperature inside the freezer, with the adjustable range of 0°C ~-81°C , which needs to be more than or equal to the internal temperature value for more than 5°C . When the set value of internal temperature is changed, if the high temperature alarm value is not more than or equal to the temperature value inside the freezer for more than 5°C , the high temperature alarm value will be automatically adjusted to "the set value of internal temperature +5°C . If the low temperature alarm value is lower than or equal to the temperature value inside the freezer for more than 5°C , the low temperature alarm value will not change.

• Initial

It can set the language, date, time. Click any one value to pop up a selection box, and then you can select more values by sliding the values in the selection box up and down. When the setting is complete, click "Save", and then you can see that the time in the upper middle of the screen will be synchronized to the set value.



[Language selection]

It can set the language types (Chinese and English, selectable).

[Time adjustment]

Set the time value to the local actual time. The default value is read from the main control board. If there is no communication with the main control board, the last displayed time shall be the default value. If the time value disaccords with local actual time, it will affect the time display of the curve.



For the operation state of compressor / fan, "Green" indicates that it is running;" Grey "indicates that it is not running.

The electronic temperature recorder is used for collect the temperature inside the freezer alone. When clicking to enter [Temp. Recorder], you can view the recorded internal temperature, and when clicking [Download], you can download the temperature data visa USB.



• Backup system

It can be used to view the operating status, injection status, accumulated injection time, and injection history. It can set when connecting with backup system, but cannot set when there's no backup system and the display will show in gray.



• Alarm record

It can be used to query the login alarm, door alarm, power alarm, battery alarm, sensor alarm, temperature alarm, condenser alarm, and backup alarm.



Input "Start time-End time", and then click "Inquiry" to query the corresponding records within this interval; when clicking "Download", you can download the recorded events through USB.

• Operating status

It can be used to query the freezer's real-time internal temperature, set temperature, high-/ low-temperature alarm value, ambient temperature, input voltage, cumulative operation time; the compressor, fan, heating wire (dual-system model)'s working state; as well as the data recorded by the electronic temperature recorder.

[Temperature scale]

Set the temperature standard, Celsius temperature standard °C and Fahrenheit temperature standard °F.

• Operation

It is used to set the alarm volume, screen brightness, Screen auto-lock, Auto-logout time, operational mode, account login mode, time delay to alarm, default display range of graph, time delay to start, ambient temperature alarm, time to door opening alarm, Update and reboot.



[Alarm volume]

The alarm volume can be adjusted by sliding it. On the left side: Minimum volume; On the right side: Maximum volume Click to enter "Mute" (🔇).

[Screen brightness]

The brightness of the liquid crystal screen can be adjusted by sliding it. On the left side: Minimum brightness; On the right side: Maximum brightness

[Screen auto-lock]

It can be used to set how long the screen will enter the sleep state for protection after having not clicked it, so as to extend the service life of the screen, with the default values of 5min, 5min, 10min, 15min, 20min, and never selectable. If you choose "never" the screen will enter the screen saver 5 minutes later. After the screen sleep, click anywhere on the LCD screen, it will automatically wake up and enter the homepage.

Choose "never" no operation within 5 mins enter screensaver.

[Auto-logout time]

It can be used to set how long the logged-in account will automatically log out after having not carried out any operation, so as to protect the account security, with the default values of 5min, 5min, 10min, 15 min and 20min (selectable).

[Operational mode]

High performance: It can provide high temperature uniformity and stability of the temperature inside the freezer, so as to store the sample with a very severe temperature control requirements on the internal temperature.

Energy saving: Compared with high-performance mode, it can save 10% of electricity, which will be used to store the sample with a not too severe temperature control requirements on the internal temperature.

[User login mode]

Ordinary: In this mode, any user can mostly use all the functions of the freezer, including setting (except user settings) and modifying some information, but can't use the message function. Under the normal mode, if a user account has been created, the mode immediately changes to the authorization mode as long as this account is logged in.

Authorized: The authorization mode can protect the data set, as only the administrator can access to change the settings. Other users can only access to check the temperature in the freezer and alarm information and use the notepad and message functions.

Mainly applicable to the freezer used by more than one person or when the requirement for safety management of the freezer is strict.

[Time delay to alarm]

It can set the time interval for alarming once again when the fault has not been eliminated after setting "Cancel alarm", including pop-up of alarm box and buzz, with the default values of 30min, 30min, 60min and 120min(selectable).

[Default range for graph]

It can set the default time range of graph display on the homepage of graph, with the default values of 2h, 2h, 4h, 6h and 12h(selectable).

[Time delay to start]

It is used to set the start-up delay time of high temperature compressor after switching on the power supply, so as to prevent multiple refrigerators from starting up at the same time, otherwise the power may be larger, resulting in insufficient power supply. Its default value is 1min, with the adjustable range of 1~15min.

[Time to door opening alarm]

It can set the alarm time of open door, with the default value of 5min(1 ~ 30min, selectable).

[Update] When connect to wifi, click "update" to check if there is latest LCD screen program in the server background. If so, it will update automatically (just available for Chinese market so far).

[Reboot] click "Reboot" to Reboot LCD screen.

[Ambient temperature alarm]

It can set the alarm temperature value of ambient temperature, with the default value of 35 °C (30 ~ 50, selectable).

• Network

It can set the network opening or closing: After the network search is completed, click the corresponding network, and enter a password for login, then connect to the network successfully. It is recommended for the user to open and then connect the wireless network, so that the touch screen can be remotely upgraded. If there is no wireless network, you can open the hot spot of the mobile phone for network connection, so as to remotely upgrade the program of touch screen.

When clicking somewhere on the graph, you can view the temperature value at a fixed point.

Input both the starting time and the ending time, and then click [Inquiry] to view the temperature graph in this interval; but if the interval is more than one month, the graph cannot be viewed.

Input both the starting time and the ending time, and then [Download] to download the temperature data within this interval through USB; but when you do not enter any time, all temperature data will be downloaded by default.

DATA can be exported in CSV or PDF, when you choose PDF, format at the interval between the start time and end time can not exceed 7days.

4. Inquiry

This page has six query buttons: Event record, Power and battery, Alarm record, Operating status, Backup system and Device information.



• Event record

It can be used to query the records of door opening/closing, setting & modification, data upload/download and account login/logout.

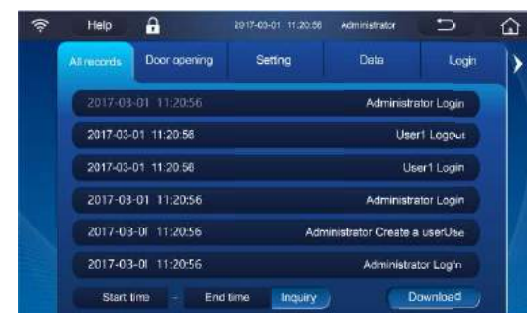

Input "Start time-End time", and then click "Inquiry" to query the corresponding records within this interval; when clicking "Download", you can download the recorded events through USB.

• Power and battery

It can be used to view both the main battery and the backup system battery's input voltage, output voltage and remaining battery level

When the electromagnetic lock is not used, the registered card can be used for account login on the login interface ;



[Delete]

Select an existing account, and then click it for login to delete the existing account.

3.Graph

It is convenient for viewing the graph of temperature inside the freezer, and it can be used to select the graph within the required time period and then download the temperature record. In addition, the graph that exceeds the alarm value of high- and low- temperature will be shown in striking red.



[2h] It can be used to quickly view the temperature graph of the last 2 hours, with the default value of 2 h(the default display range of graph can be set in the operation settings);

[24h] It can be used to quickly view the temperature graph of the last 24 hours

[7day] It can be used to quickly view the temperature graph of the last 7 days

[one month] It can be used to quickly view the temperature graph of the last 1 month

In the graph chart, the middle line is the line of the set temperature inside the freezer; the upper / lower line is high-/low- temperature alarm value respectively.

The graph can be enlarged by sliding the screen.



Network name: connected successful wifi name.



• Backup

It can set ON/OFF of backup system, type of backup system, and injection temperature, meanwhile can projected injection time.It can set when connecting with backup system, but cannot set when there's no backup system and the display will show in gray.



[Backup system]

When the user uses a backup system (optional), click "On"; and then click "Off" after the completion of use.

[Backup system type]

Two types of liquid nitrogen(LN₂)and liquid carbon dioxide(LCO₂) are available for selection(by default of liquid nitrogen).

[Set injection temperature]

Set the temperature when the backup system starting spraying: For liquid nitrogen, the default temperature is -70℃ , with the adjustable range of 0 ~-100 ℃ ; and for carbon dioxide, the default temperature is -70 ℃ , with the adjustable range of 0 ~-70℃ ; meanwhile, the set spraying temperature shall not be lower than the high-temperature alarm value. When the set spraying temperature is lower than the high-temperature alarm value, it can not be saved.

[Projected injection time]

When installing a backup system, the user can fill in the estimated usable time of the installed backup system. When need to confirm the remaining conditions after the backup system has been used, the user can query its cumulative spraying time, and then judge the usage conditions of the backup system through the difference between these two.

[Injection test]

When the temperature inside the freezer does not reach the set spraying temperature, you can click "Injection test" to simulate the spraying conditions, so as to confirm whether the spraying system can be normally used. If the displayed temperature inside the freezer ≥ the set temperature, after pressing the button of "Injection test", the displayed temperature is unchanged, and the indicator light of backup system on the homepage is ON; at this time, control to open the solenoid valve for spraying, and stop the spraying 10 seconds later. If he displayed temperature inside the freezer < the set temperature, after pressing the button of "Injection test", the displayed temperature changes rapidly to the set temperature;at this point, control to open the solenoid valve for spraying, and stop the spraying 10 seconds later; after that, the displayed temperature will return back to the actual temperature inside the freezer.

• User

It can add, edit, delete user accounts, as well as set the user account permissions.

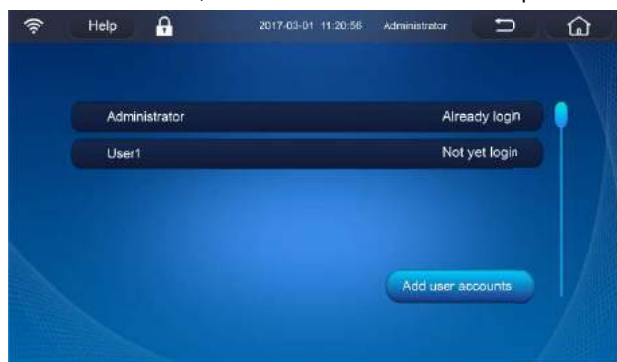

[Add Account]

Click "Add user accounts" to create a new user account.



User: In authorization mode, normal user can only view, query and save the freezer's information, as well as use message and note book functions, but cannot set the freezer.

Administrator: In authorization mode, only with administrator permissions, can the settings be changed. With administrator permissions, you can not only use all the functions of the freezer, but also change the authorization mode into the normal mode.

Register fingerprint : When using a fingerprint lock (optional), click "Register fingerprint " to pop up the prompt for fingerprint registration, and then complete the registration of fingerprint on the freezer. After that, the user can open the door by using the fingerprint or log in the account in the authorization mode. When unlocking the lock, press the fingerprint directly; when logging in an account, select "Register fingerprint " on the login screen.

When the electromagnetic lock is not used, the registered fingerprint can be used for account login on the login interface under the authorization mode;



Register Card: When using a card-punching lock (optional), click "Register Card" to pop up the prompt for card registration, and then complete the registration of IC card on the freezer. After that, the user can open the door by punching the card or log in the account in the authorization mode. When unlocking the lock, punch the card directly in the unlocking zone; when logging in an account, select "Register Card" on the login screen.